



Doosan Infracore  
Construction Equipment

# DX300LL

Engine Power : SAE J1995, gross 151kw(202HP)/1,900rpm

SAE J1349, net 147kw(197HP)/1,900rpm

Operational Weight : 35,100kg(77,381 lb) - STD.



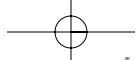

# DX300LL

The new DX300 log loader has all the advantages of the previous model, and now offers additional added value to the operator.



The new DX300LL was developed with the concept of "providing optimum value to the end user." In concrete terms, this translates, into :

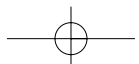

## Doosan DX300LL Hydraulic Excavator : A New Model with Novel Features



**Increased production** and improved fuel economy is attributed to the electronic optimization of the hydraulic system and the new generation DOOSAN engine (Tier III / Stage III).

**Improved ergonomics**, increases comfort and excellent all round visibility ensuring a safe and pleasant working environment.

**Improved reliability** is achieved through the use of high performance materials combined with new methods of structural stress analysis, and leads to increased component life expectancy, thus reducing running costs.

**Reduced maintenance** increases the availability and reduces operating costs of the excavator.

# HANDLING

The log loader's power, durability, ease of servicing and its precise control increase its effectiveness and life expectancy. With the DX300LL, DOOSAN offers an excellent return on investment.



Multi-function Color LCD Monitor Panel

Warning lights

Operation modes

- Mode selection
- Flow rate control
- Auto deceleration
- Display selection

Control panel  
With color LCD display

### Choice of operating modes

#### Working mode

- Digging mode: for general excavation, loading, lifting...
- Trenching mode: swing priority for trench work, canal digging, embankments...

#### Power mode

- Standard: uses 85% engine power for all work
- Power: uses 100% engine power for heavy work



### Control lever

Very precise control of the equipment increases versatility, safety and facilitates tricky operations requiring great precision.

Leveling operations and particularly the movement of suspended loads are made easier and safer.

The control levers have additional electrical buttons for controlling other additional equipment (for example, grabs, crushers, grippers, etc.)

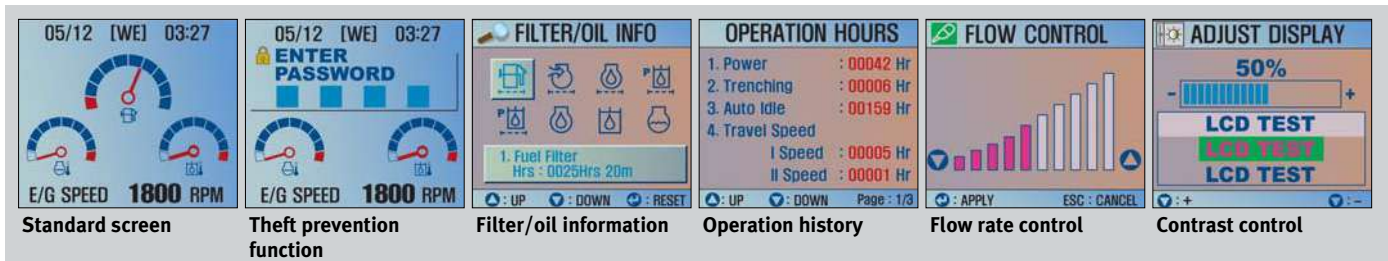

Cellular phone box



12V Power socket



Cigarette lighter



Glass antenna

# COMFORT

DX300LL

**The work rate of the log loader is directly linked to the performance of its operator. DOOSAN designed the DX300LL by putting the operator at the centre of the development goals. The result is significant ergonomic value that improves the efficiency and safety of the operator.**

More space, better visibility, air conditioning, a very comfortable seat... These are all elements that ensure that the operator can work for hours and hours in excellent conditions.



**Control panel**  
Correct positioning with clear controls makes the operator's task easier.



The high performance air conditioning provides an air flow which is adjusted and electronically controlled for the conditions. Five operating modes enable even the most demanding operator to be satisfied.



**Air suspension seat (opt)**  
Equipped with various functions of adjustment forth and back and, and lumbar support, it reduces the vibration of equipment transmitted during work in an effective way. Also for considering winter working environment, Seat warmer functions equipped.



Appropriate storage spaces show the attention given to the operator.



**Comfortable 2-stage sliding seat**



**Control stand (Telescopic Function)**



**MP3/CD Player (Opt.)**



**Audio Button**

Audio Button has been positioned in a way that the driver can turn on/off the radio, control the volume, and select a channel conveniently.

# PERFORMANCE

The performance of the DX300LL has a direct effect on its productivity. Its new "Common Rail" engine and new e-EPOS controlled hydraulic system have combined to create an unbeatable log loader, with a cost/performance ratio that makes the DX300LL even more appealing.



**"COMMON RAIL" DOOSAN DLo8 ENGINE**

At the heart of the hydraulic excavator is the new "Common Rail" DOOSAN DLo8 engine. It is combined with the new e-EPOS electronic control system, for optimum power and fuel saving.

The new engine produces 197 hp(147 kw/200 PS) at only 1,900 rpm, and more torque, due to its careful design combined with the use of common rail injection and 4 valves per cylinder. These features help optimize combustion and minimize pollution through reduced Nox & particulate emissions.

Increased torque allows efficient use of the power of the hydraulic system.

- Faster working cycles increase productivity.
- Increased torque means the excavator is able to move more easily.
- Energy efficiency reduces fuel consumption.

DOOSAN infracore is aware of the importance of protecting the environment. Ecology was uppermost in the minds of the research workers right from the start of the design of the new machines. The new challenge for the engineers is to combine the protection of nature with equipment performance and to this end DOOSAN has been investing heavily.

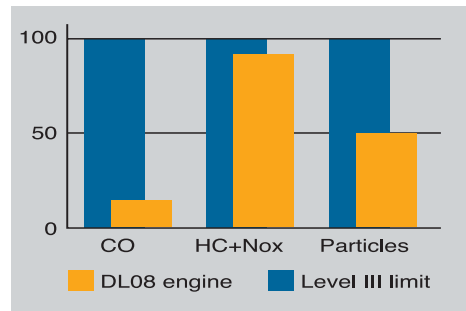
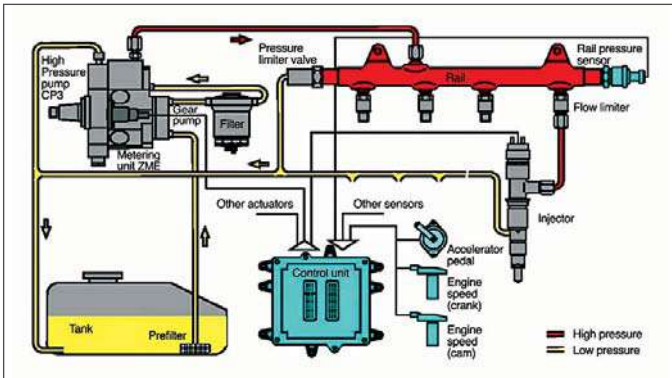

The new DOOSAN engine respects and protects the environment, limiting all types of toxic emissions.

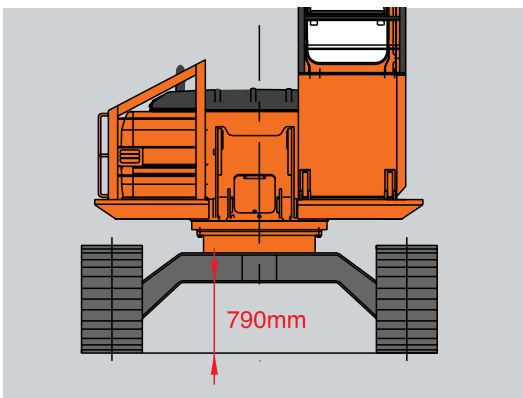

### Stable lower running part

Heightening the lowest ground level to 790mm (2'7"), it prevents the damage of the lower part in running at a rough area and swampy land.

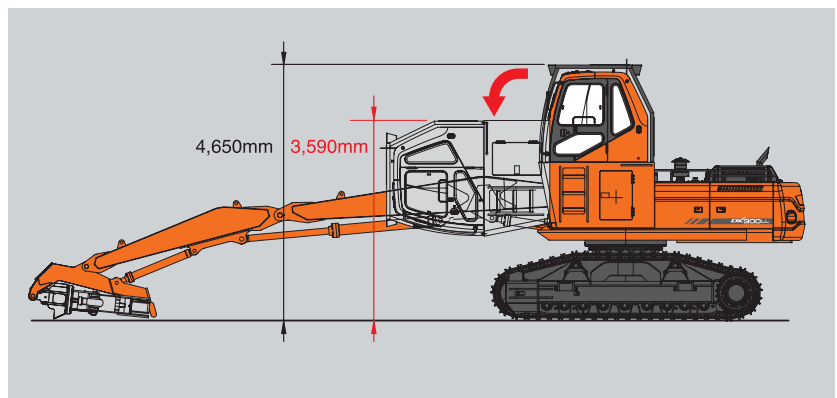

### Folding type cabin

Lowering the ground level with the cabin folded forth at transport, it is easy to move. (4,650mm (15'3") → reduced to 3,590mm (11'9"))

DX300LL

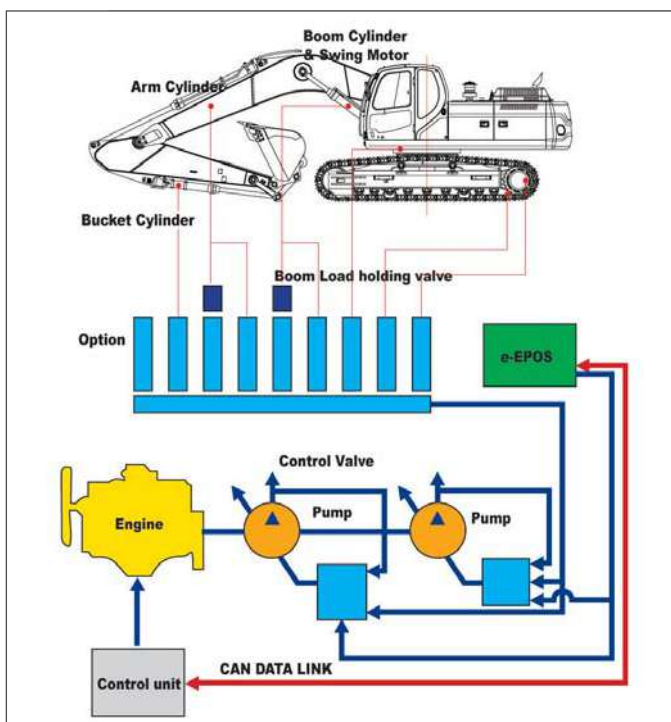

## EXCAVATOR CONTROL

### New e-EPOS system (Electronic Power Optimizing System)

The brains of the hydraulic excavator, the e-EPOS, have been improved and now can electronically link to the engine's ECU (Electronic Control Unit), through a CAN (Controller Area Network) communication link, enabling a continuous exchange of information between the engine and the hydraulic system. These units are now perfectly synchronised.

The advantages of the new e-EPOS impacts at several levels, Ease of operation and user-friendliness:

- The availability of a power mode and a normal operating mode guarantee maximum efficiency under all conditions.
- Electronic control of fuel consumption optimizes efficiency.
- The automatic deceleration mode enables fuel saving.
- Regulation and precise control of the flow rate required by the equipment are available as standard.
- A self-diagnosis function enables technical problems to be resolved quickly and efficiently.
- An operational memory provides a graphic display of the status of the machine.
- Maintenance and oil change intervals can be displayed.

# RELIABILITY

The reliability of an item of plant contributes to its overall lifetime operating costs. DOOSAN uses computer-assisted design techniques, highly durable materials and structures then test these under extreme conditions

Durability of materials and longevity of structures are our first priorities.



#### Cabin protector

To perfectly protect a driver from a dangerous object such as wood or stone, a guard is equipped at the upper and front part of the cabin. (Meeting international standard ISO 10262)

Equipped with 4 lamps at the upper part of the guard, it is convenient to work at night.

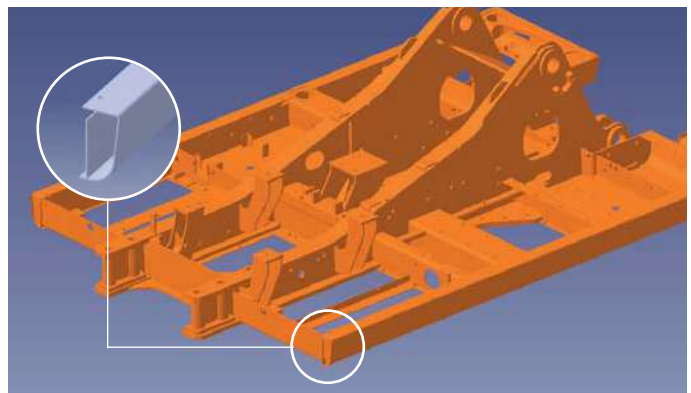

#### D-type frame

The D-type frame design adds strength and minimizes distortion due to shocks.



#### Pump coupling

A polymer material is used to produce the coupling between the pump and engine. This material has a long life and reduces noise and vibration levels.



#### Low roller

With improvement of lower roller body internal structure, and strict test verification of reliability, it has secured a higher level endurable quality, and a full guard was applied to protect the lower roller and prevent the derailment from a track at a rugged area work.



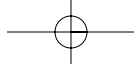

DX300LL



**Travel motor**

Running drive force improved with the efficiency improvement of the running device, its performance is excellent at a slope or swampy area.



**Integrated track spring and idler**

The track spring and the idler have been joined directly to achieve high durability and improved maintenance convenience.

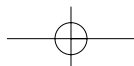

# MAINTENANCE

Short maintenance operations at long intervals increase the availability of the equipment on site. DOOSAN has developed the DX300LL with a view to high profitability for the user.



### Engine oil filter

The engine oil filter offers a high level of filtration allowing the oil change interval to be increased to 500 hours. It is easy to access and is positioned to avoid contaminating the surrounding environment.



### Easy maintenance

Access to the various radiators and coolers is very easy, making cleaning easier. Access to the various parts of the engine is from the top and via side panels.



### Hydraulic oil return filter

The protection of the hydraulic system is more effective, using glass fiber filter technology in the main oil return filter. This means that with more than 99.5% of foreign particles filtered out, the oil change interval is increased.



### Air cleaner

The large capacity forced air cleaner removes over 99% of airborne particles, reducing the risk of engine contamination and making the cleaning and cartridge change intervals greater.



### Fuel filter

High efficiency fuel filtration is attained by the use of multiple filters, including a fuel pre-filter fitted with a water separator that removes most moisture from the fuel.

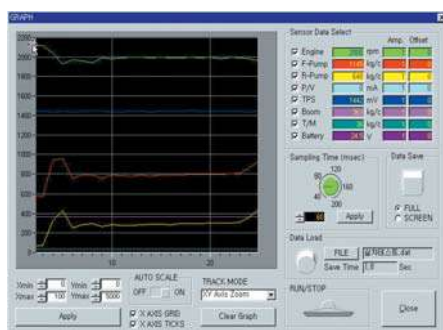

### PC Monitoring (DMS)

A PC monitoring function enables connection to the e-EPOS system, allowing various parameters to be checked during maintenance, such as pump pressures, engine rotation speed, etc. and these can be stored and printed for subsequent analysis.



### Convenient Fuse Box

The fuse box is conveniently located in a section of the storage compartment behind the operator's seat providing a clean environment and easy access.

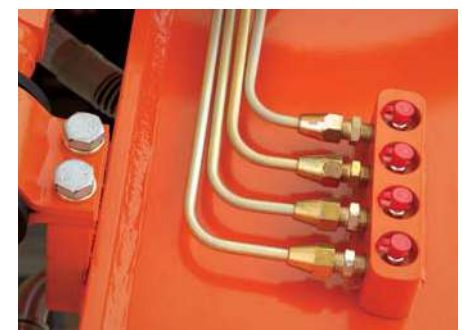

### Centralized grease inlets for easy maintenance

The arm grease inlets are grouped for easy access.

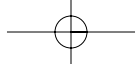

# DX300LL

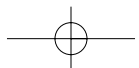

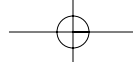

# TECHNICAL SPECIFICATIONS

## \* ENGINE

### • Model

Doosan DLo8  
"Common Rail" engine with direct fuel injection and electronic control, 4 valves per cylinder, vertical injectors, water cooled, turbo charged with air to air intercooler. The emission levels are well below the values required for phase III

### • Number of cylinders

6

### • Nominal flywheel power

151 kW(202HP) at 1,900 rpm (SAE J1995, gross)  
147 kW(197HP) at 1,900 rpm (SAE J1349, net)

### • Max torque

93 kgf.m(912 Nm) at 1,300 rpm

### • Piston displacement

7,640 cc (466cu.in)

### • Bore & stroke

108 mm x 139 mm (4.3" X 5.5")

### • Starter

24 V / 6 kW

### • Batteries

2 x 12 V / 150 Ah

### • Air cleaner

Double element and pre-filtered Turbo with auto dust evacuation.

## \* HYDRAULIC SYSTEM

The heart of the system is the e-EPOS (Electronic Power Optimizing System). It allows the efficiency of the system to be optimized for all working conditions and minimizes fuel consumption.

The new e-EPOS is connected to the engine electronic control via a data transfer link to harmonize the operation of the engine and hydraulics.

- The hydraulic system enables independent or combined operations.
- Two travel speeds offer either increased torque or high speed tracking.
- Cross-sensing pump system for fuel savings.
- Auto deceleration system.
- Two operating modes, two power modes.
- Button control of flow in auxiliary equipment circuits.
- Computer-aided pump power control.

### • Main pumps

2 variable displacement axial piston pumps  
max flow: 2 x 246  $\text{dm}^3/\text{min}$  (2 X 65US gpm, 2 X 54 Imp gpm)

### • Pilot pump

Gear pump - max flow: 28.5  $\text{dm}^3/\text{min}$  (7.5US gpm, 6.3 Imp gpm)

### • Maximum system pressure

Boom/arm/heel:

Normal mode: 330  $\text{kgf/cm}^2$  (324 bar)

Power mode: 350  $\text{kgf/cm}^2$  (343 bar)

Travel: 335  $\text{kgf/cm}^2$  (328 bar)

Swing: 275  $\text{kgf/cm}^2$  (270 bar)

## \* WEIGHT

Boom 6,300 mm (20'8") • Arm 3,910 mm (12'10") • Grapple None

	Shoe width	Operating weight	Ground pressure (kgf/cm <sup>2</sup> )
Double grouser	600 mm (2')	34,800 kg (76,720 lb)	0.67 kgf/cm <sup>2</sup> (66 kpa, 9.5 psi)
	(Std) 700 mm (2'4")	35,100 kg (77,381 lb)	0.58 kgf/cm <sup>2</sup> (57 kpa, 8.2 psi)
	800 mm (2'8")	35,400 kg (78,043 lb)	0.51 kgf/cm <sup>2</sup> (50 kpa, 7.3 psi)

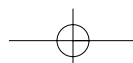

## \* HYDRAULIC CYLINDERS

The piston rods and cylinder bodies are made of high-strength steel. A shock absorbing mechanism is fitted in all cylinders to ensure shock-free operation and extend piston life.

Cylinders	Quantity	Bore x Rod diameter x stroke
Boom	2	150 X 100 X 1,190mm(5.9" X 3.9" X 3'11")
Arm	1	180 X 120 X 1,405mm(7.0" X 4.7" X 4'7")
Heel	1	150 X 100 X 1,010mm(5.9" X 3.9" X 3'4")

## \* UNDERCARRIAGE

Chassis are of very robust construction, all welded structures are designed to limit stresses.

High-quality material used for durability.

Lateral chassis welded and rigidly attached to the undercarriage. Track rollers lubricated for life, idlers and sprockets fitted with floating seals.

Tracks shoes made of induction-hardened alloy with double grouser.

Heat-treated connecting pins.

Hydraulic track adjuster with shock-absorbing tension mechanism.

### • Number of rollers and track shoes per side

Upper rollers: 2 (standard shoes)
Lower rollers: 9
Shoes: 51
Total length of track: 4,920mm (16'2")

## \* ENVIRONMENT

Noise levels comply with environmental regulations (dynamic values).

### • Sound level guarantee

104 dB(A) (2000/14/EC)

### • Cab sound level

73 dB(A) (ISO 6396)

## \* SWING MECHANISM

- An axial piston motor with two-stage planetary reduction gear is used for the swing.
- Increased swing torque reduces swing time.
- Internal induction-hardened gear.
- Internal gear and pinion immersed in lubricant bath.
- The swing brake for parking is activated by spring and released hydraulically.

**Swing speed: 0 to 9.9 rpm**

## \* DRIVE

Each track is driven by an independent axial piston motor through a planetary reduction gearbox.

Two levers with control pedals guarantee smooth travel with counter-rotation on demand.

### • Travel speed (fast/slow)

4.6/3.1km/h (2.9/1.9mph)

### • Maximum traction force

19,700 / 27,800 kgf (61,288lbf)

### • Maximum grade

35° / 70%

## \* REFILL CAPACITIES

### • Fuel tank

500 ℓ (132.1 US gal, 110 Imp gal)

### • Cooling system (Radiator capacity)

35 ℓ (9.2 US gal, 7.7 Imp gal)

### • Engine oil

36 ℓ (9.5 US gal, 7.9 Imp gal)

### • Swing drive

6 ℓ (1.6 US gal, 1.3 Imp gal)

### • Final drive (each)

5.5 ℓ (1.5 US gal, 1.2 Imp gal)

### • Hydraulic system

480 ℓ (126.8 US gal, 105.6 Imp gal)

### • Hydraulic tank

280 ℓ (74 US gal, 61.6 Imp gal)

# DIMENSIONS

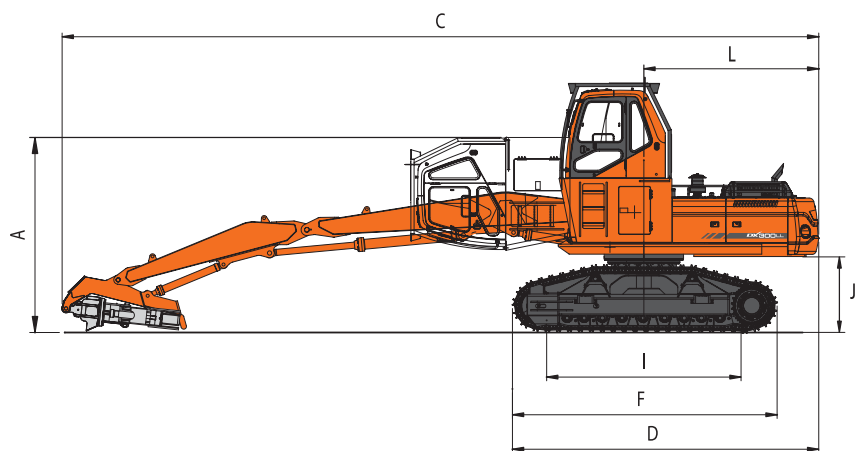
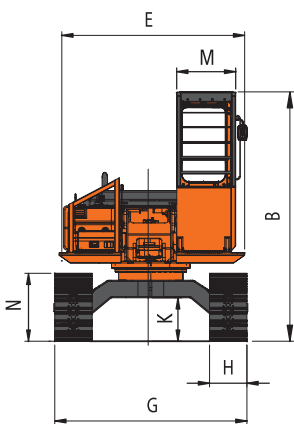

## \* DIMENSIONS

Boom 6,300 mm (20'8") - Arm 3,910 mm (12'10") - Grapple None - Shoes 700 mm (2'4") - Std

<b>A</b>	<b>Overall Transport Height W/Attachment</b>	3,590mm(11'9")
<b>B</b>	<b>Overall Height</b>	4,650mm(15'3")
<b>C</b>	<b>Overall Length</b>	14,540mm(47'8")
<b>D</b>	<b>Overall Length (Without Attachment)</b>	5,675mm(18'7")
<b>E</b>	<b>Width of Upper Structure</b>	3,480mm(11'5")
<b>F</b>	<b>Track Overall Length</b>	4,920mm(16'2")
<b>G</b>	<b>Track Overall Width</b>	3,600mm(11'10")
<b>H</b>	<b>Track Shoe Width</b>	700mm(2'4")
<b>I</b>	<b>Tumbler Distance</b>	4,010mm(13'2")
<b>J</b>	<b>Countweight Clearance</b>	1,415mm(4'8")
<b>K</b>	<b>Minimum Ground Clearance</b>	790mm(2'7")
<b>L</b>	<b>Tail Swing Radius</b>	3,200mm(10'6")
<b>M</b>	<b>Cabin Guard Width</b>	1,105mm(3'8")
<b>N</b>	<b>Track Height</b>	1,250mm(4'1")

# WORKING RANGES

## DX300LL

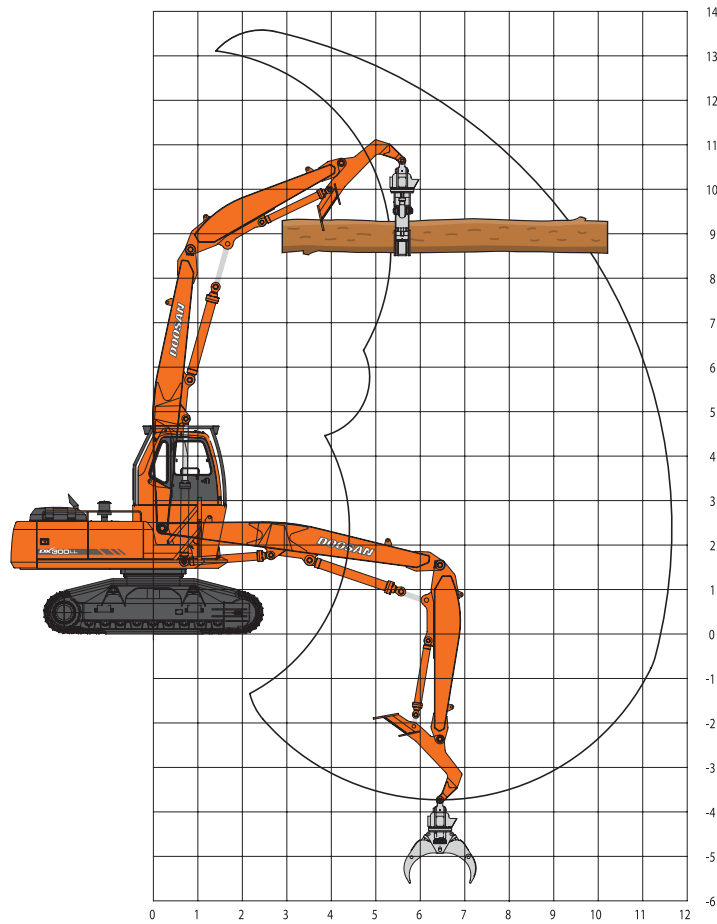

### \* WORKING RANGE

Max. Loading reach	11,650mm (38'3")
Max. Loading Depth	3,728mm (12'3")
Max. Loading Height	13,580mm (44'7")
Rear swing radius	3,200mm (10'6")
Min. swing radius	4,182mm (13'9")

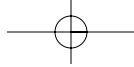

# LIFTING CAPACITY

DX300LL

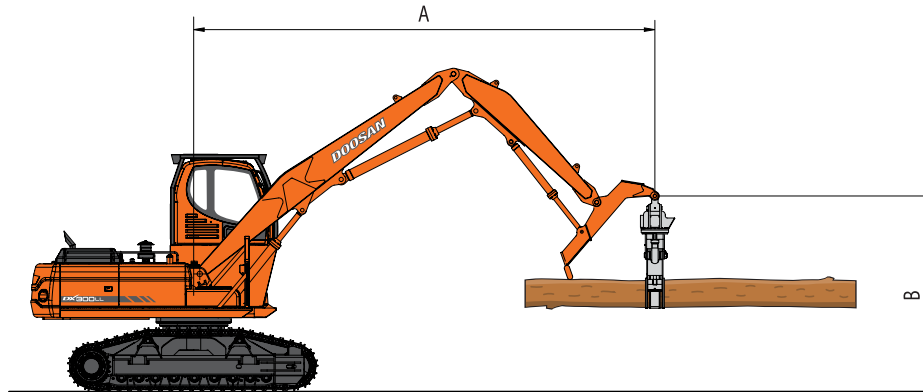

## Metric

Boom : 6,300mm(20'8") Arm : 3,910mm(12'10") Grapple : None Shoe : 700mm(2'4") - Std

Unit : 1,000kg

A(m) \ B(m)	3.05m		4.57m		6.10m		7.62m		9.14m		10.67m	
12.19m			11.508	11.508	9.498	9.498						
10.67m					8.759	8.759	8.342	7.366				
9.14m					8.237	8.237	7.825	7.593	7.480	5.529		
7.62m					8.364	8.364	7.788	7.661	7.330	5.557		
6.10m					9.018	9.018	8.119	7.584	7.416	5.566	5.806	4.218
4.57m	8.255	8.255	10.111	10.111	8.695	7.403	7.498	5.489	5.774	4.187		
3.05m			14.089	14.089	11.263	10.129	9.358	7.149	7.366	5.362	5.738	4.150
1.52m			16.402	14.701	12.397	9.607	9.562	6.890	7.226	5.230	5.688	4.105
0 (Ground)			11.245	11.245	12.959	9.222	9.335	6.681	7.112	5.121	5.656	4.073
-1.52m	4.069	4.069	7.661	7.661	12.610	9.027	9.213	6.568	7.058	5.071	5.652	4.069
-3.05m			11.335	11.335	11.331	8.986	8.763	6.536				

## Feet

Unit : 1,000lb

A(ft) \ B(ft)	10ft		15ft		20ft		25ft		30ft		35ft	
40ft			*25.37	*25.37	*20.94	*20.94						
35ft						*19.31	*19.31	*18.39	16.24			
30ft						*18.16	*18.16	*17.25	16.74	*16.49	12.09	
25ft						*18.44	*18.44	*17.17	16.89	*16.16	12.25	
20ft						*19.88	*19.88	*17.90	16.72	*16.35	12.27	12.80
15ft			*18.20	*18.20	*22.29	*22.29	*19.17	16.32	16.53	12.10	12.73	9.23
10ft			*31.06	*31.06	*24.83	*22.33	*20.63	15.76	16.24	11.82	12.65	9.15
5ft			*36.16	32.41	*27.33	21.18	21.08	15.19	15.93	11.53	12.54	9.05
0 (Ground)			*24.79	*24.79	*28.57	20.33	20.58	14.73	15.68	11.29	12.47	8.98
-5ft	*8.97	*8.97	*16.89	*16.89	*27.80	19.90	20.31	14.48	15.56	11.18	12.46	8.97
-10ft			*24.99	*24.99	*24.98	19.81	*19.32	14.41				

1. Ratings are based on SAE J1097
2. The load point is a hook located on the back of the bucket.
3. \* Rated loads are based on hydraulic capacity.
4. Rated loads do not exceed 87% of hydraulic capacity or 75% of tipping capacity.

: Rating Over Front

: Rating Over Side or 360 degree

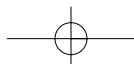



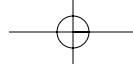

# STANDARD AND OPTIONAL EQUIPMENT

## \* STANDARD EQUIPMENT

### ▪ Hydraulic system

- Boom and arm flow regeneration
- Boom and arm holding valves
- Swing anti-rebound valves
- Spare ports(valve)
- One-touch power boost

### ▪ Cabin & Interior

- Viscous cab mounts
- All weather sound suppressed type cab
- Air conditioner
- Adjustable suspension seat with head rest and adjustable arm rest
- Pull-up type front window and removable lower front window
- Room light
- Intermittent windshield wiper
- Cigarette lighter and ashtray
- Cup holder
- Hot & Cool box
- LCD color monitor panel
- Fuel control dial
- AM/FM radio and cassette player
- Remote radio ON/OFF switch
- 12V spare powers socket
- Serial communication port for laptop PC interface
- Joystick lever with 3 switches
- Sunvisor
- Sun roof

### ▪ Safety

- Large handrails and step
- Punched metal anti-slip plates
- Seat belt
- Hydraulic safety lock lever
- Safety glass
- Hammer for emergency escape
- Right and left rearview mirrors
- Travel alarm

### ▪ Others

- Double element air cleaner
- Pre-cleaner
- Water separator
- Dust screen for radiator/oil cooler
- Engine overheat prevention system
- Engine restart prevention system
- Self-diagnostic system
- Alternator(24V, 50 amps)
- Electric horn
- Halogen working lights(frame mounted 2, boom mounted 2)
- Hydraulic track adjuster
- Track guards
- Double fuel filter
- Greased and sealed track link

## \* OPTIONAL EQUIPMENT

Some of these optional equipments may be standard in some markets. Some of these optional equipments cannot be available on some markets. You must check with the local DOOSAN dealer to know about the availability or to release the adaptation following the needs of the applications.

### ▪ Safety

- Boom and arm hose rupture protection valve
- Overload warning device
- Cabin Top/Front guard(ISO 10262, FOGS standard)
- Travel & swing alarm
- Rotation beacon

### ▪ Cabin & Interior

- Air suspension seat
- MP3/CD player

### ▪ Others

- Piping for crusher
- Piping for quick clamp
- Breaker filter
- 700mm/800mm/850mm shoe
- Full track guards
- Lower wiper
- Fuel heater
- Double grouser shoe

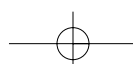

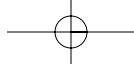

**Seoul Office :**  
 Doosan Tower 27<sup>th</sup> FL. 18-12, Euljiro-6 Ga,  
 Jung-Gu, Seoul, Korea 100-730  
 Tel : +82-2-3398-8114  
 Fax : +82-2-3398-8117  
[www.doosaninfracore.com](http://www.doosaninfracore.com)

**Doosan Infracore Europe S.A.**  
 1A, Rue Achille Degrace, 7080 Frameries, Belgium  
 Tel : +32-65-61-3230 Fax : +32-65-67-7338

**Doosan Infracore U.K., Ltd.**  
 Doosan House, Unit 6, 3 Heol Y Gamlas, Parc Nantgarw, Nantgarw,  
 Cardiff. CF15 7QU, U.K.  
 Tel : +44-1443-84-2273 Fax : +44-1443-84-1933

**Doosan Infracore Europe S.A. Germa**  
 Heinrich-von- Stephan str. 2 40764 Langenfeld, Germany  
 Tel : +49-2173-2035-210 Fax : +49-2173-2035-219

**Doosan Infracore France**  
 ZAC de La Clef Saint Pierre - Buroplus 2 1A Avenue Jean d'Alembert  
 78990 Elancourt, France  
 Tel : +33-(0)1-30-16-21-41 Fax : +33-(0)1-30-16-21-44

**Doosan Infracore America Corporation**  
 2905 Shawnee Industrial Way, Suwanee, Georgia 30024, U. S. A  
 Tel : +1-770-831-2200 Fax : +1-770-831-0480

**Doosan Infracore China Co., Ltd.**  
 #28, Wuzhishan Road, Eco. & Tech, Development Zone,  
 Yantai, Shandong, China  
 Tel : +86-535-638-2000 Fax : +86-535-638-2004

**Doosan Infracore South Africa (PTY) LTD.**  
 60C Electron Road, Isando 1600, Johannesburg, South Africa  
 Tel : 27-11-974-2095 Fax : 27-11-974-2778

**Doosan Infracore Middle East Center (Dubai)**  
 P.O.Box 183127, Al-Serkal Building, Air Port Road, Dubai, U.A.E  
 Tel : +971-4-295-2781~2 Fax: +971-4-295-2783

**Doosan Infracore Latinamerica oficina (Colombia)**  
 Diagonal 127A No. 17-34, oficina 302 Bogota, Colombia  
 Tel : +571-216-1655 Fax: +571-648-7700

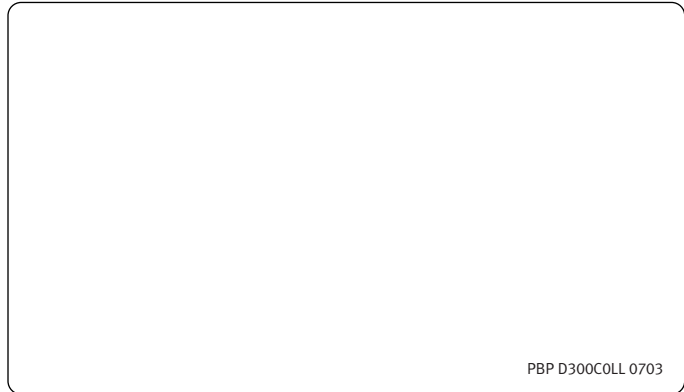

PBP D300COLL 0703

The illustrations do not necessary show the product in standard version.  
 All products and equipment are not available in all markets.  
 Materials and specifications are subject to change without prior notice.

