

DOOSAN

Articulated Dump Truck

DA30 / DA45

Maximum power (ISO 3046)	276KW(375HP) / 368KW(500HP)
Maximum payload	28 m t (31 s t) / 41 m t (45 s t)
Body capacity heaped (With tailgate)	17.8 / 26.1 m ³



PRODUCTIVITY

The DA30 offers best-in-class ground clearance & ground bearing pressure. Combined with superior torque at low engine RPM, and superior power and traction, we offer you the best productivity.

OPERATOR'S ENVIRONMENT

Ergonomic controls, most spacious cab in the market, high-class seat, Bluetooth radio with USB, and much more...

OPERATE AT EASE

Upgraded monitor panel, new control panel for more convenient use, real-life payload meter with external light indication, rear-view camera, body tip boost button, etc.

POWER

Scania DC 09 engine: 276 kW (375 HP) at 2100 rpm with electronic exhaust brake.

NEW QUALITY OF RIDE

New self-leveling, hydro-gas suspension supports soft ride in harsh conditions.

MANEUVERABILITY

Unique design of rear frame, body, and front-mounted differential on transmission make the Doosan machine the most compact ADT in its class, which results in smallest turning radius and outstanding stability.

DIFFERENTIAL

Front and rear differentials are limited slip, longitudinal differential can be manually locked by pushing 1 button.



SAFETY HIGHLIGHTS

Gradient meter with body flip-over protection, Body Over Centre of Gravity function, fenders and hand rails all around cab, superior stability and always visible and clean front cab access.

BODY

Steel plates with 400 HB hardness. Capacity without/with tailgate : 16.8/17.8 m³. Tailgate, body heating & wear plates available as optional equipment.

DOOSAN CONNECT

TELEMATICS

Monitor your fleet online. As standard, Doosan Connect system with dual mode (satellite, GSM). Check productivity, fuel consumption, system warnings, maintenance status, etc.

BRAKE SYSTEMS

Oil-cooled wet disc brakes (lifetime up to 15,000 hours). Standard hydraulic transmission retarder & hydraulic parking brake.

SERVICE ACCESSIBILITY

Diesel and grease (for auto-lube system) filling from ground level. Easy access to filters and oil filling points. Tilttable cab with self-positioning locking mechanism.



✓ TAKE A TOUR OF THE DA45

DA30
DA45

PRODUCTIVITY

The Doosan DA45 offers the best combination of payload and efficiency in its class. Thanks to its unique design, best productivity is delivered in all working conditions.

OPERATOR'S ENVIRONMENT

Ergonomic controls, most spacious cab in the market, high-class seat, Bluetooth radio with USB, and much more...

OPERATE AT EASE

Upgraded monitor panel, new control panel for more convenient use, real-life payload meter with external light indication, rear-view camera, body tip boost button, etc.

POWER

Scania DC13 water-cooled diesel engine with turbo charger and air to air intercooler (368kw at 2100rpm).

NEW QUALITY OF RIDE

New self-leveling, hydro-gas suspension supports soft ride in harsh conditions.

MANEUVERABILITY

Unique design of rear frame, body, and front-mounted differential on transmission make the Doosan machine the most compact ADT in its class, which results in smallest turning radius and outstanding stability.

DIFFERENTIAL

Front and rear differentials are limited slip, longitudinal differential can be manually locked by pushing 1 button.



SAFETY HIGHLIGHTS

Gradient meter with body flip-over protection, Body Over Centre of Gravity function, fenders and hand rails all around cab, superior stability and always visible and clean front cab access.

BODY

Steel plates with 400 HB hardness. Capacity without/with tailgate : 24.5/26.1 m³. Tailgate, body heating & wear plates available as optional equipment.

DOOSAN CONNECT

TELEMATICS

Monitor your fleet online. As standard, Doosan Connect system with dual mode (satellite, GSM). Check productivity, fuel consumption, system warnings, maintenance status, etc.

BRAKE SYSTEMS

Oil-cooled wet disc brakes (lifetime up to 15,000 hours). Standard electronic engine brake, hydraulic transmission retarder & parking brake.

SERVICE ACCESSIBILITY

Diesel, AdBlue (T4F only) and grease (for auto-lube system) filling from ground level. Easy access to filters and oil filling points. Tilttable cab with self-positioning locking mechanism.

TOP PERFORMANCE AND FUEL EFFICIENCY

DA30
DA45

THE POWER TO RAISE PRODUCTIVITY

The Doosan ADT concept offers a larger load capacity in all weight categories. Additional load capacity, combined with superior power and traction, improve productivity. The unique advantages of the Doosan ADT's permanent 6-wheel drive, free-swinging rear tandem, front-mounted turning ring, independent front wheel suspension, and sloping rear frame provide excellent driving stability with equal weight distribution and superior traction. The Doosan Articulated Dump Truck is designed to work under very tough conditions and travel up to 55 km/h.



DESIGN SIMPLICITY

Permanent 6-wheel drive, together with the ground-following rear tandem and our special front-mounted turning ring, provide equal power & weight distribution and excellent operating performance. The sloping rear frame provides a lower centre of gravity - improving the ADT's overall stability, and ensuring fast and easy tipping of the body for increased productivity.



Front-mounted articulation hinge

2 limited-slip differentials

1 manual differential lock

Sloping rear frame

Gear-driven tandem axle



ENGINES – LOWER EMISSIONS / SAME GREAT PERFORMANCE

Doosan ADTs use only proven, reliable and powerful diesel Scania engines with excellent torque, which achieve low fuel consumption and meet Tier2/3/4F regulation requirements.

NEW SELF-LEVELING HYDRO-GAS FRONT SUSPENSION

The DA30's design was based on the successful and proven design of the DA45. It has been upgraded with the self-leveling system for better shock absorption in changing operating conditions.

PAYLOAD METER

Our standard real-life payload & load count meter provides the Doosan operator and owner with an immediate indication of the productivity. External indication lights help load the body more efficient.

DOWNHILL SPEED MODULATION

Powerful hydraulic retarder keeps machine's speed constant on downhill without support of service brakes. Operator can easily adjust the retarder's power by lever or simply pushing the gas pedal.

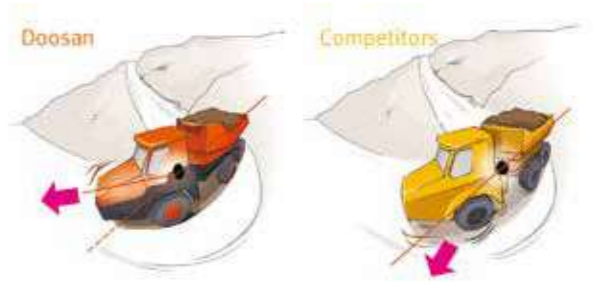

TRANSPORTABILITY

Thanks to its less than 3-meter width, the DA30 can be moved easily from one site to another. And thanks to the compact design of both machines, a shorter low loader can be used.

FORWARD-MOUNTED TURNING RING

The turning ring is located in front of the articulation point, ensuring equal weight distribution to the front wheels in all operating situations, including maximum turning. The equal weight distribution enables you to use the limited slip differentials with only 45% locking value - ensuring drive to both front wheels in all situations, without completely locking the wheels.

TRACTION

The Doosan ADT's unique design offers permanent 6-wheel drive, ensuring stability and equal weight distribution to accommodate all job applications. The Doosan ADTs superior driveline ensures maximum traction and durability.



OPERATE IN COMFORT

DA30 DA45

QUIETEST TRUCK IN THE INDUSTRY

The spacious ROPS/FOPS cab is equipped with climate control and a high-quality operator seat with air suspension to provide excellent comfort. Precise steering, good visibility, low noise levels (71dB ISO 6396) and optional vertical movement provide additional comfort and quiet.

- The sloping hood gives the operator an excellent view
- The cab is mounted on a special rubber suspension to reduce vibration and conduction of noise into the cab

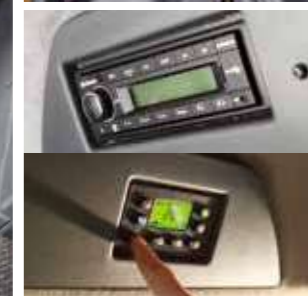
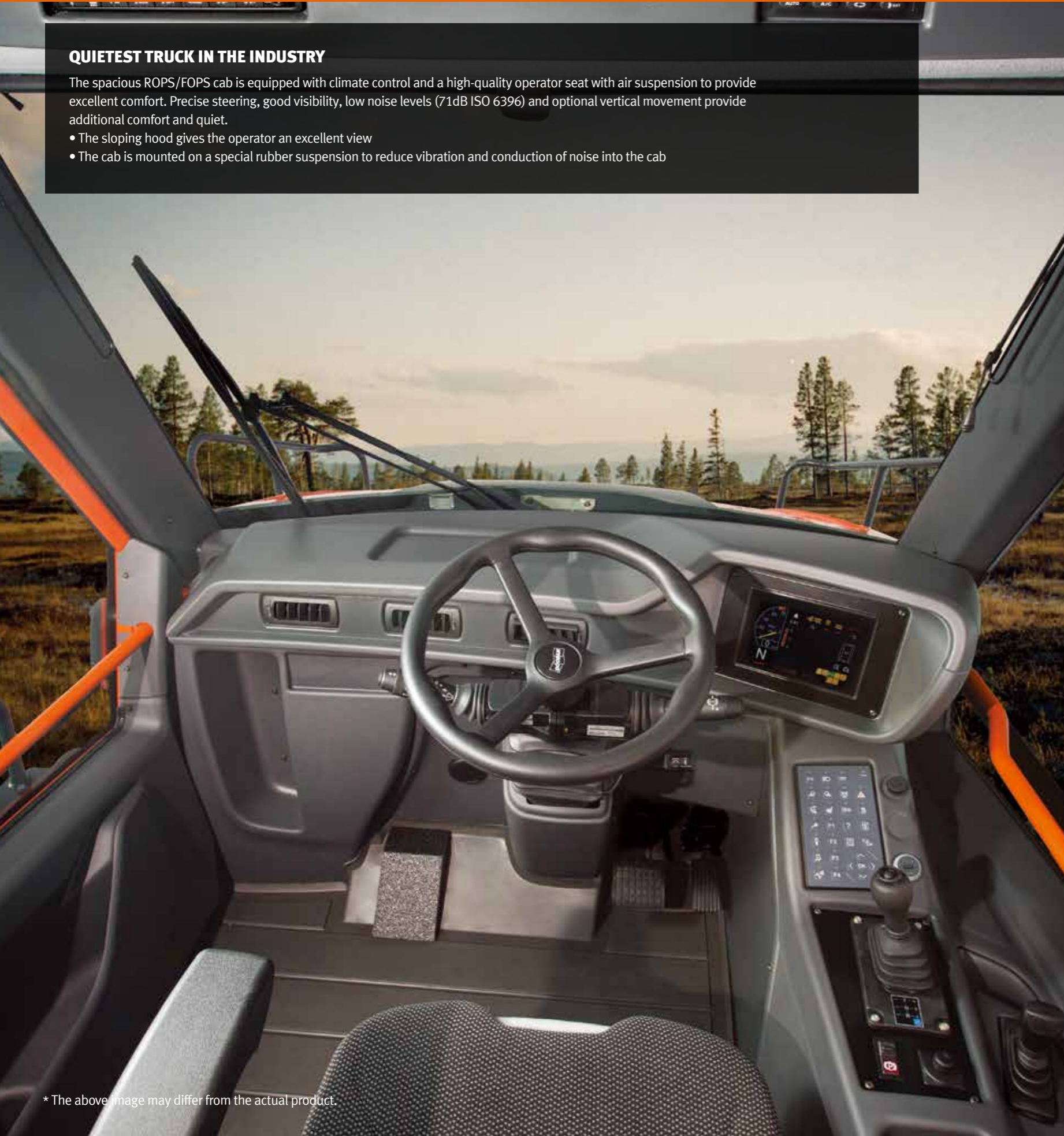

BEST-IN-CLASS OPERATOR ENVIRONMENT

The cab was designed based on the feedback received directly from hundreds of Doosan operators. This resulted in upgrade of the cab in features and functions required by the market, including: hand grip on the right side, foot rest, improved storage room, USB charger, Bluetooth radio, all around rails outside the cab, additional lever for retarder control and a number of other new features.

HIGH-COMFORT AIR-SUSPENSION SEAT

Because a highly comfortable seat means a lot to every operator, we provide an air-suspension seat with armrest as standard.

ONE KEY SOLUTION

To enter and safely operate your Doosan ADT, you need just 1 key to lock and unlock all the doors and also start the engine.

SELF-LEVELING, HYDRO-GAS FRONT SUSPENSION

New suspension system has outstanding performance in rough terrain due to big shock absorption capacity of the hydraulic suspension cylinders. On top of that, the self-leveling system can adjust to match changing working conditions.

STORAGE COMPARTMENTS WITH EXTRA 12V POWER SUPPLY

Plenty of storage spaces, plus extra room designed to fit cool/hot box with additional 12V power supply.

MP3, DAB AND BLUETOOTH

Standard radio supports all modern features like MP3, DAB and Bluetooth

CLIMATE CONTROL

Our specially designed climate control is easy to operate and highly efficient - keeping you comfortable at all times.

* The above image may differ from the actual product.



TOTAL CONTROL IN ALL SIMPLICITY

DA30 DA45

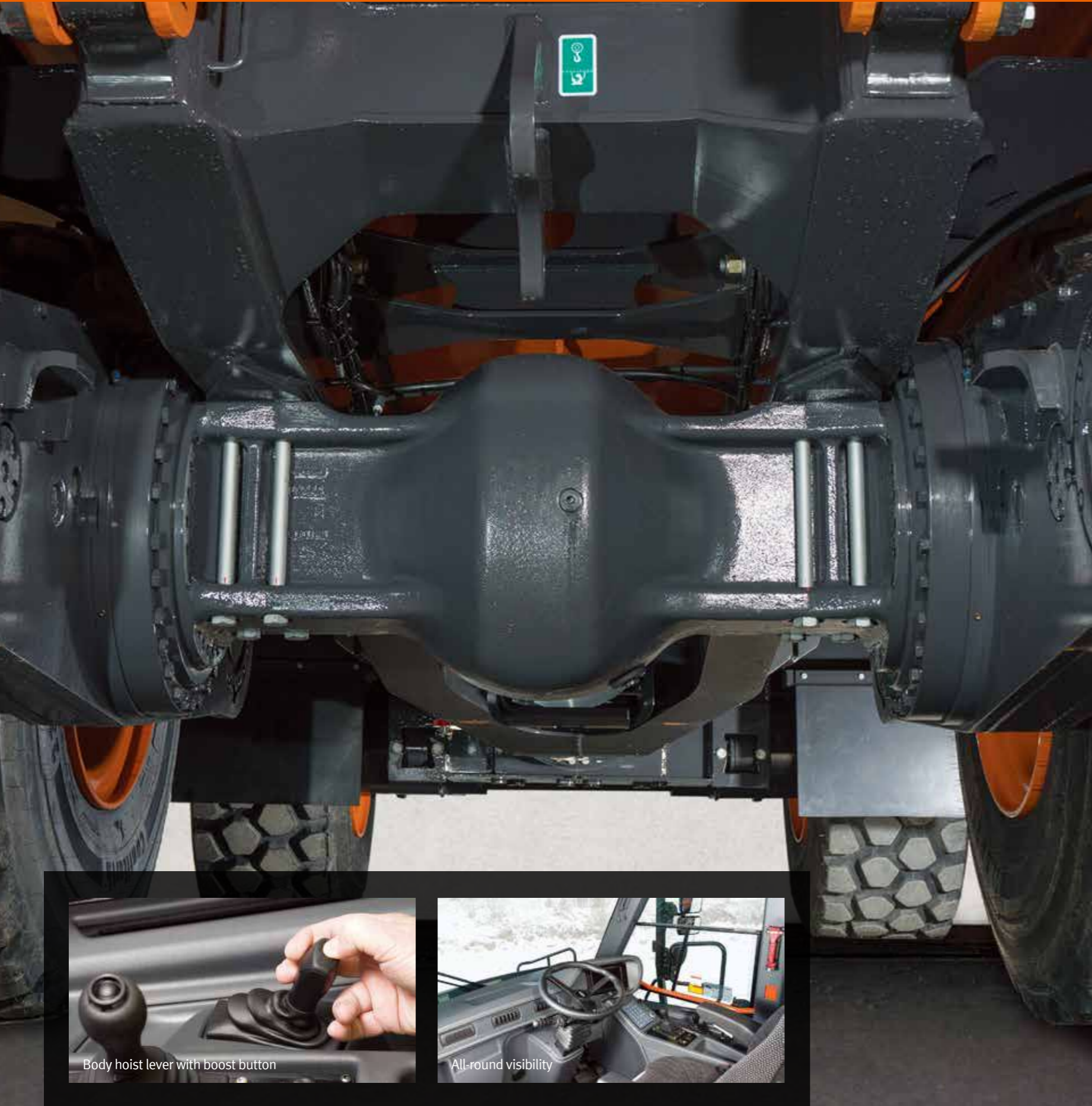

OPERATE AT EASE IN YOUR COMFORT ZONE

The Doosan ADT is one of the industry's simplest trucks to operate and, at the same, time offers a large number of functions. Comfortably seated in this class-leading operator cab, you'll enjoy easy operation combined with excellent efficiency. And thanks to the upgraded monitor panel, you'll operate in your comfort zone.

- Bigger indications
- Multiple languages
- Integrated payload meter (as standard)
- Diagnostic section with transmission and hydraulic oil level check function
- Gradient meter indication for increased safety while operating
- Integrated rear-view camera (as standard)

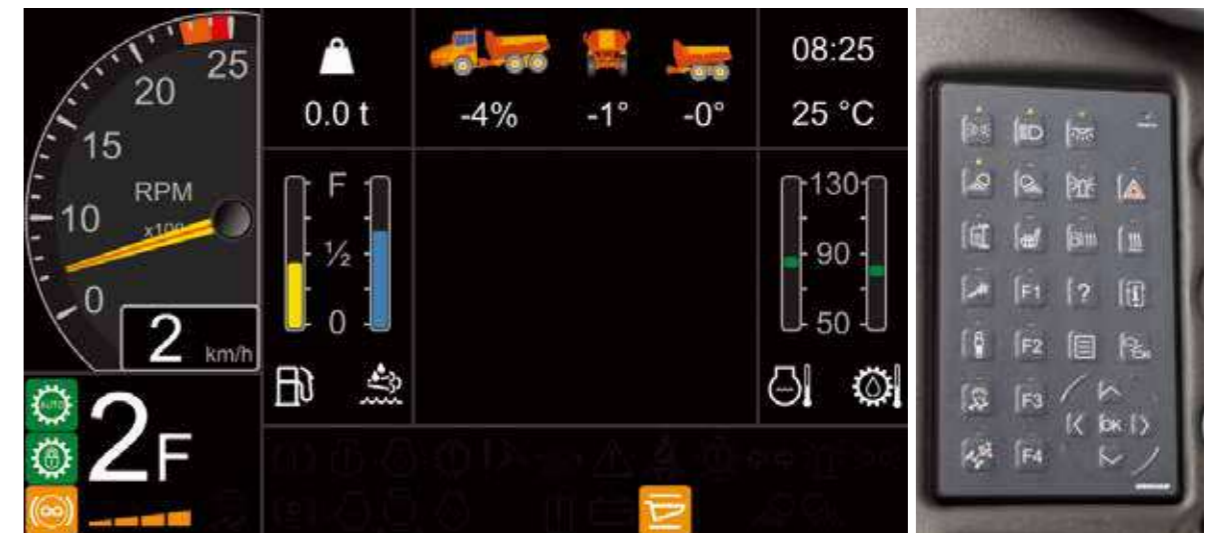

LCD COLOR MONITOR PANEL

- 7" color display, resolution 800 x 480 pixels
- Shows all necessary information for driving and handling the machine
- Rear-view camera image embedded in instrumentation graphics
- Backlight dimming according to ambient light conditions
- Sub-menus for additional and diagnostic functions

TOUCH PAD

- Diesel fuel heater
- Longitudinal differential lock
- Override button
- Cab roof and mirror arm front lights
- Hazard lights
- Operating work-lights

DIFFERENTIAL ACTIVATION

With automatic limited slip differentials, automatic and manual transmission shift, power steering, "simple touchpad" and "easy to read" display, every ADT is as simple to use & operate as possible.

BODY HOIST LEVER

The new body hoist lever is easy to operate and fingertip controlled. This electronically managed hoist lever incorporates a higher body up speed and an automatic body down feature, with soft touch down, to keep you safe at all times.

"TIP-TRONIC" GEAR SHIFT

To ensure the smoothest possible gear shifts and momentum, you can run the truck in both automatic and manual gears.

RETARDER FORCE MODULATION LEVER

New lever located on the right-hand side below the steering wheel enables operator to choose from 4 power modes. On top of that, the gas pedal is responsible for retarder power reduction.



Body hoist lever with boost button



All-round visibility

* The above image may differ from the actual product.



SIMPLE MAINTENANCE WITH GREAT UPTIME

DA30
DA45

ACCESS MAIN FILLING POINTS WHILE STANDING ON THE GROUND

Improved simplicity of maintenance and service reduces failure rate and improves lifetime and longevity. Convenient position of liquids' levels check and filling points, easy access to filters and very low number of rubber wearing components significantly reduce labor time.



- Easy access to factory-fitted standard automatic central lubrication system
- Dedicated space for grease cartridge and grease gun.
- Easy access to filters
- Diesel and AdBlue (T4F only) filling points accessible from the ground level
- Diesel tank prepared for fast fill coupler
- LED light indicates when power isolator can be switched off
- Power isolator in convenient and safe location
- External power supply



- Multifunctional display with available service/maintenance functions
- Transmission oil level check
- Status of hydraulic and electronic components

TRAINING CENTER

Located in the heart of Europe, near Prague (Czech Republic), the Doosan Academy is a dynamic center of knowledge where Product, Service and Doosan University training courses are held.

The facilities include a modern building that can accommodate all of the product ranges, and an outdoor training area where we conduct field exercises and product testing with the fleet of Doosan machines and attachments.

FILTERS

All filters are centralized for quicker and easier accessibility.

GLOBAL DOOSAN NETWORK

With a network of Doosan Dealers & Parts Distribution Centers worldwide, your Doosan trucks can be serviced & maintained wherever you are.

TELEMATICS

The Doosan Connect system is available for reading out vehicle operating & production parameters remotely, and providing you with total ease-of-mind. Keep day-by-day overview on the machine's productivity, status and condition.



* The above image may differ from the actual product.



TELEMATICS SERVICE



GLOBAL PARTS NETWORK

TELECOMMUNICATIONS

Data flow from machine to web



TELEMATICS SERVICE TERMINAL

Telematics Service terminal is installed to machine / connected to EPOS™



TELECOMMUNICATION

GPS, EPOS™ data is sent to designated server by GSM, Satellite telecommunication



DOOSAN TELEMATICS SERVICE WEB

Doosan, Dealer, Customer can easily monitor the GPS, EPOS™ data from Core Telematics Service web

BENEFITS

JOB SITE MANAGEMENT



WORK EFFICIENCY MANAGEMENT



PREVENTIVE MAINTENANCE



PROACTIVE SERVICE



FUNCTIONS

Location

- GPS
- Geo-fence



Reports

- Periodic operation report
- Utilization



Operation Trend

- Total operation hour
- Operation hour by mode



Fuel Efficiency*

- Fuel level
- Fuel consumption



Filter & Oil Management

- Preventive maintenance by item replacement cycle



Warning & Alert

- Detect machine warnings
- Antenna disconnection
- Geo/Time fence

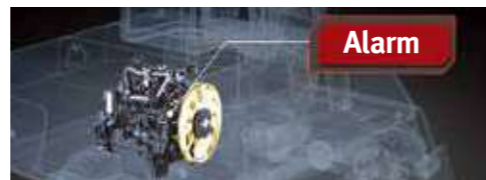

* Functions may not be applied to all models. Please contact your sales representative to get more information of the service.

TELEMATICS SERVICE BENEFITS

Customer

- Improve work efficiency
- Timely and preventive service
- Improve operator's skills by comparing work pattern
- Manage fleet more effectively

Dealer

- Better service for customers
- Provide better quality of service
- Maintain machine value
- Better understanding of market needs

Doosan

- Responsive to customer's voice
- Utilize quality-related field data
- Apply customer's usage profile to developing new machine

GLOBAL PDC (PARTS DISTRIBUTION CENTER) NETWORK

Doosan provides fast and precise worldwide delivery of genuine Doosan parts through its global PDC (parts distribution center) network.

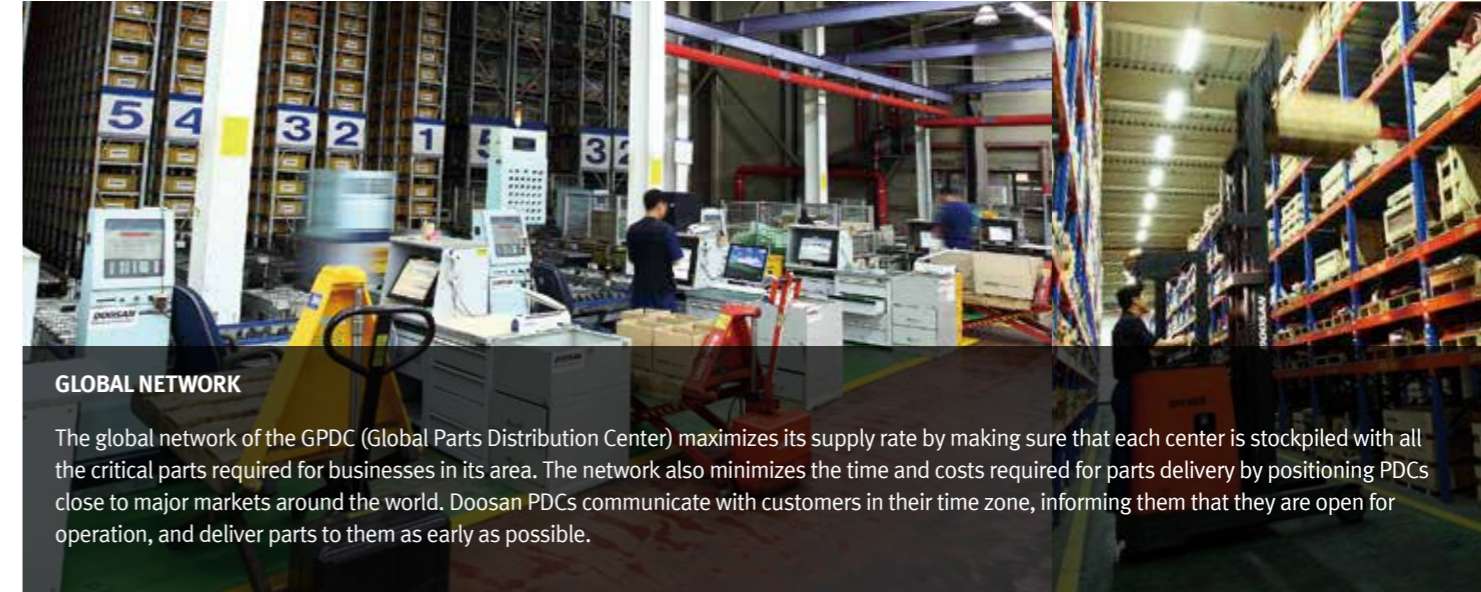

The Global Parts

Distribution Center Network

PDCs had been set up as shown below, including Mother PDC in Ansan, Korea.

The nine other PDCs include one in China (Yantai), three in the USA (Chicago, Atlanta, Miami), one in Brazil (Americana), two in Europe (U.K. and Germany), one in the middle East (Dubai) and one in Asia (Singapore)

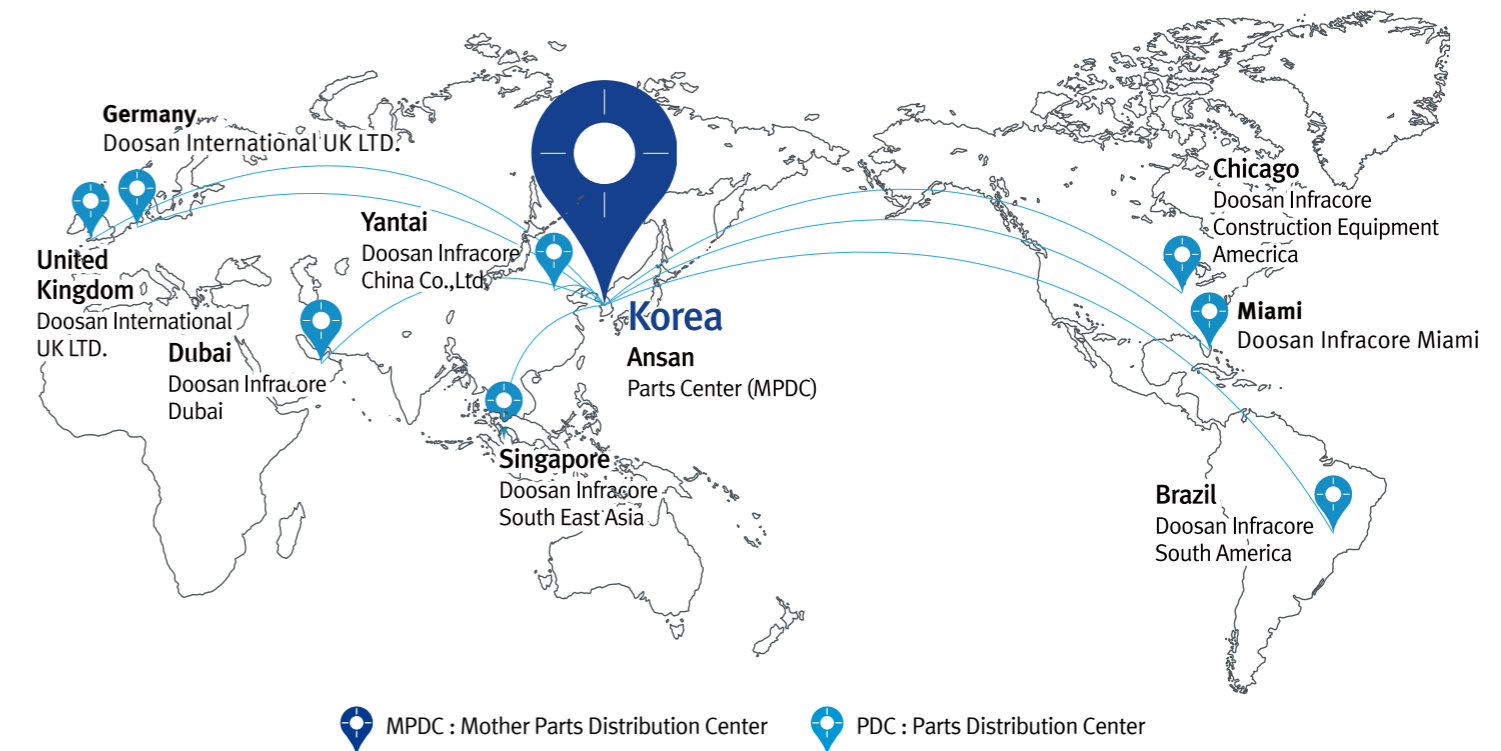

PDC BENEFIT

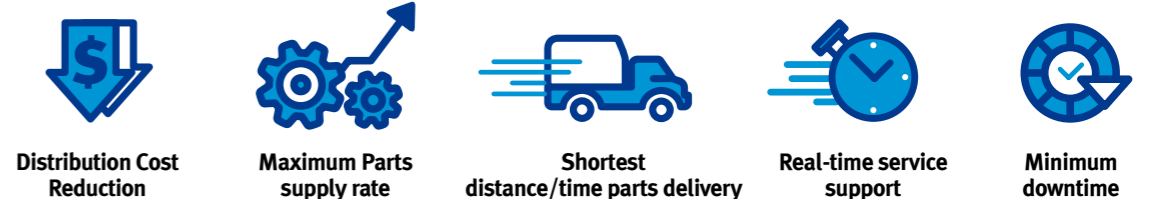

- Distribution Cost Reduction**
- Maximum Parts supply rate**
- Shortest distance/time parts delivery**
- Real-time service support**
- Minimum downtime**

TECHNICAL SPECIFICATIONS

DA30

BODY

Body volume (without Tailgate)

16.8 m³ – 22.0 yd³

Material

Hardened abrasion-resistant steel plates (400 HB)

Tilt cylinders

Single stage, double-acting

Tipping time

Up : 12 sec. / Down : 10 sec.

Body

Designed for exhaust heating

Sloping frame

Down from the hinge point

Level capacity (with/without tailgate)

14.2 m³ / 13.6 m³ – 18.6 yd³ / 17.8 yd³

Heaped capacity (with/without tailgate)

17.8 m³ / 16.8 m³ – 23.3 yd³ / 22.0 yd³

ELECTRICAL SYSTEM

Batteries

2 x 12V 105Ah (series connected to give 24V)

Starter

6KW (8HP)

Alternator

24 V 100 A

WEIGHTS

Empty : Front axle

12500 kg – 27558 lb

Empty : Rear axle

10600 kg – 23369 lb

Max. admissible axle load: Front axle

16700 kg – 36817 lb

Max. admissible axle load: Rear axle

37000 kg – 81571 lb

Max. admissible weight

51200 kg – 112877 lb

Payload

28 metric ton – 31 short ton

Net weight

23200 kg – 51147 lb

NOTE: All weights include a full fuel tank and operator

POWER TO WEIGHT RATIO (NET POWER VS TON)

Empty

11.9 kW/t

Loaded

5.4 kW/t

GROUND PRESSURE

Ground pressure

Standard 23.5 x 25 tyres with 15% sinkage

Empty : Front axle

121.7 kPa – 17.65 psi

Empty : Rear axle

51.6 kPa – 7.48 psi

Loaded : Front axle

161.6 kPa – 23.44 psi

Loaded : Rear axle

169.8 kPa – 24.63 psi

CAPACITIES

Fuel tank

335 l

Hydraulic system

95 l

Hub front

9.6 (2) l

Tandem housing, rear differential and hubs

155 (2) l

Cooling circuit

45 l

ENGINE

35 l

ENGINE

Complies with Tier2, Tier4F emission

Scania DC 9, water-cooled, diesel engine with turbo charger and air-to-air intercooler

Power rating ISO 3046 @ 2100 rpm

Tier2 375hp(267kW) / Tier4F 375hp(276kW)

No. of cylinders

5 (in line)

Gross torque

1873Nm @1300rpm

Cylinder volume

9.3 litres

Bore diameter x stroke

130 x 140 mm

Air filter

Dry type

SPEEDS

Speeds

Forward – Reverse

Forward 1 – 2 – 3 – 4 – 5 – 6 – 7 – 8

6 - 8 - 11 - 16 - 23 - 32 - 45 - 55 km/h

Reverse 1 – 2 – 3 – 4

6 - 8 - 11 - 16 km/h

TRANSMISSION

Electronically-controlled automatic transmission with retarder. The torque converter has automatic lock-up in all gears.

ZF 8 EP320

HYDRAULIC SYSTEM

1 variable displacement piston pump for steering & tipping for cooling fan, brakes & auxiliaries

294 l/min @ 2100 rpm

Filtration

One return flow filter

Main safety valves pressures, tipping/steering circuit

280 / 210 bar

TIRES

Standard

23.5 R25 Tubeless, two Star radial

TECHNICAL SPECIFICATIONS

DA45

BODY

Body volume (without Tailgate)

24.6 m³ – 31.9 yd³

Material

Hardened abrasion-resistant steel plates (400 HB)

Tilt cylinders

Single stage, double-acting

Tipping time

Up: 10 sec. / Down: 10 sec.

Body

Designed for exhaust heating

Sloping frame

Down from the hinge point

Level capacity (with/without tailgate)

20.4 m³ / 19.6 m³ – 26.7 yd³ / 25.6 yd³

Heaped capacity (with/without tailgate)

26.1 m³ / 24.6 m³ – 47.1 yd³ / 31.9 yd³

ELECTRICAL SYSTEM

Batteries

2 x 12V 105Ah (series connected to give 24V)

Starter

6KW (8HP)

Alternator

24 V 100 A

WEIGHTS

Empty : Front axle

14500 kg – 31967 lb

Empty : Rear axle

16000 kg – 35274 lb

Max. admissible axle load: Front axle

22500 kg – 49604 lb

Max. admissible axle load: Rear axle

55000 kg – 121254 lb

Max. admissible weight

71100 kg – 156749 lb

Payload

41 metric ton – 45 short ton

Net weight

30100 kg – 66359 lb

NOTE: All weights include a full fuel tank and operator

POWER TO WEIGHT RATIO (NET POWER VS TON)

Empty

11.8 kW/t

Loaded

5.0 kW/t

GROUND PRESSURE

Ground pressure

Standard 29.5 x 25 tyres with 15 % sinkage

Empty : Front axle

93.9 kPa – 13.62 psi

Empty : Rear axle

51.8 kPa – 7.51 psi

Loaded : Front axle

139.2 kPa – 20.19 psi

Loaded : Rear axle

161.3 kPa – 23.39 psi

CAPACITIES

Fuel tank

530 l

Hydraulic system

100 l

AdBlue tank (T4F only)

70 l

Hub front

9.6 (2)

Tandem housing, rear differential and hubs

228 (2)

Cooling circuit

50

ENGINE

45

ENGINE

Complies with Tier 2 /3 /4F emissions

Scania DC 13, water-cooled, diesel engine with turbo charger and air-to-air intercooler

Power rating ISO 3046 @ 2100 rpm

Tier2 500hp(368kW) / Tier3 450hp(331kW) / Tier4F 500hp(368kW)

No. of cylinders

6 (in line)

Gross torque

2373 Nm @ 1300 rpm

Cylinder volume

12.7 litres

Bore diameter x stroke

130 x 160 mm

Air filter

Dry type

SPEEDS

Speeds

Forward – Reverse

Forward 1 – 2 – 3 – 4 – 5 – 6 – 7 – 8

6 - 9 - 12 - 17 - 24 - 34 - 48 - 55 km/h

Reverse 1 – 2 – 3 – 4

6 - 9 - 12 - 17 km/h

TRANSMISSION

Electronically-controlled automatic transmission with retarder. The torque converter has automatic lock-up in all gears.

ZF 8 EP420

HYDRAULIC SYSTEM

1 variable displacement piston pump for steering & tipping for cooling fan, brakes & auxiliaries

294 l/min @ 2100 rpm

Filtration

One return flow filter

Main safety valves pressures, tipping/steering circuit

280 / 210 bar

TIRES

Standard

29.5R25 Tubeless, two Star radial

SPECIAL FEATURES

DA30/DA45 SPECIAL FEATURES

Suspension

- Front: Semi-independent, self-leveling hydro-gas suspension.
- Rear: Free-swinging tandem housing.

Articulation hinge and steering

- Articulation hinge with forward-mounted turning ring.
- Steering cylinders (two): Double-acting.
- The steering is approved according to ISO 5010.
- Max. steering angle : 45°.
- Ground-driven emergency steering pump.

Driveline

- Full-time 6 x 6 drive with two transverse differentials and one longitudinal.
- Front axle transverse differential : Limited-slip diff lock with 45% locking ratio.
- Rear axle transverse differential : Limited-slip diff lock with 45% locking ratio.
- Inter-axle longitudinal differential :
 - Torque-proportioning differential, integrated into the ZF transmission.
 - Torque distribution :
 - 1/3 to the front axle
 - 2/3 to the rear axle
 - 100 % lockable
- Tandem housing: Gear driven, free - swinging Provides equal drive to rear wheels and ensures the best possible ground contact – whatever the ground conditions.

Brake system

- Dual circuit braking system acting on all six wheels.
- Approved according to ISO 3450.
- All hydraulic-operated brakes with enclosed oil-cooled wet multiple discs on four hubs (braking force distributed to two hubs by tandem gear wheels)
- Spring actuated hydraulic released parking brake, mounted on driveline shaft.
- Max. gradient, parking brake : 20°.
- Automatic transmission retarder as standard.

Cab

- Approved to ROPS/FOPS standards (ISO 3471, ISO 3449).
- Low interior sound level : 71dB (ISO 6396).
- External sound level : 106db (ISO 6395).
- The cab is centrally located on rubber mountings.
- Hand and arm vibrations are less than 2.5 ms² (ISO 5349).
- Whole body vibration is less than 0.5 ms² (ISO 2631).
- Superior visibility – for safer operation.
- Superior operating controls location.
- Adjustable suspended operator seat.
- Adjustable steering column.
- Climate control – Heater and air conditioning.
- Tilting for service access.
- All-around hand rails.

DIMENSIONS

DA30

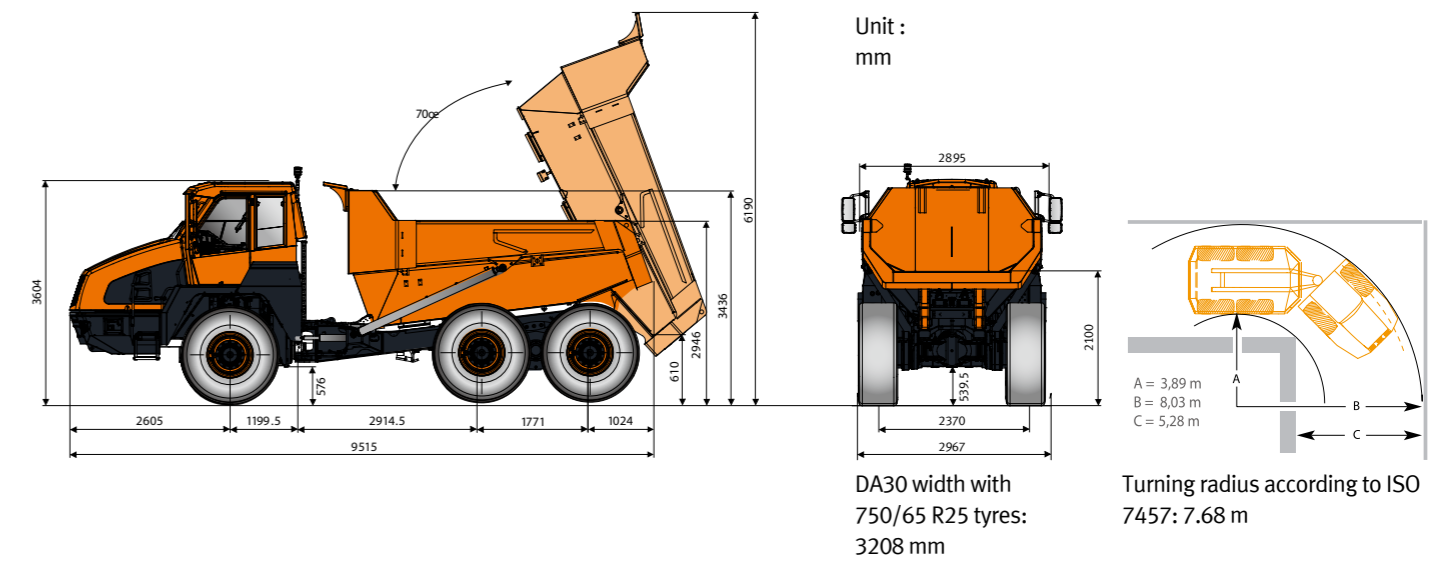

DA45

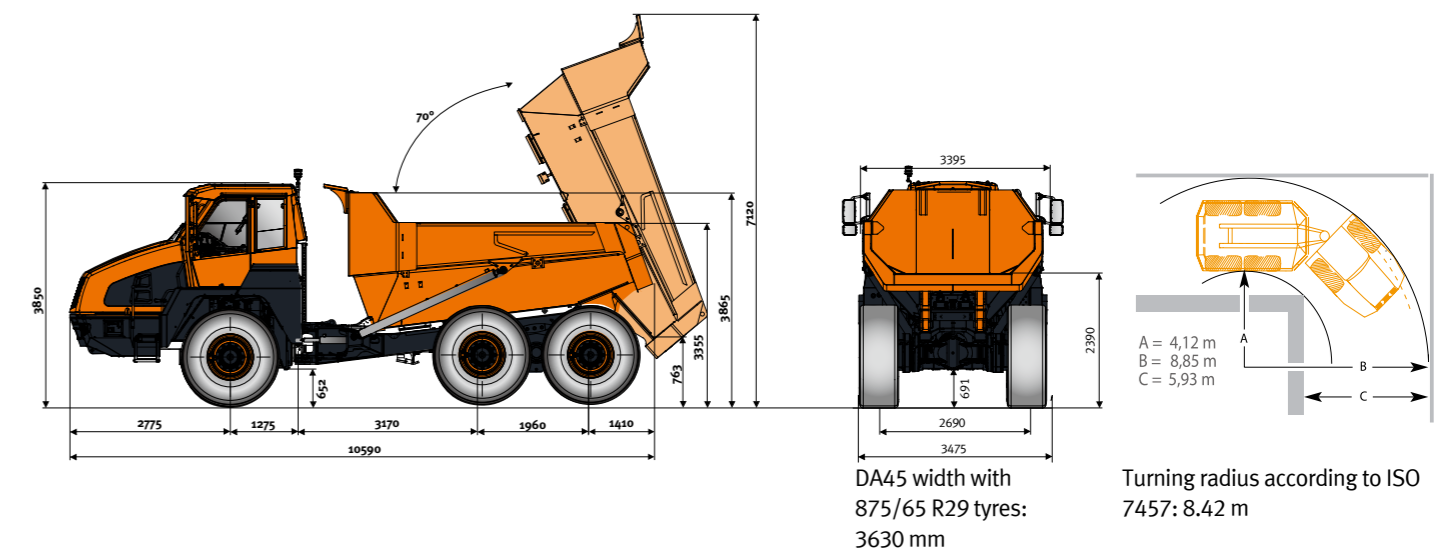

STANDARD AND OPTIONAL EQUIPMENT

STANDARD EQUIPMENT

Engine

- Electronically controlled, direct injected, water-cooled, turbocharger, air-to-air intercooler
 - Preheater for easier cold starts
 - Exhaust brake

Hydraulic System

- 1 variable displacement piston pump for steering & tipping
- One return flow filter

Safety

- Gradient meter with anti-flip-over protection system
- Payload meter & cycle counter
- Wet disc brake
- Rear-view camera
- Hammer for emergency escape
- Hand rails on the fenders

Other

- Transmission retarder brake
- Automatic lubrication system
- Mud flaps
- Towing hook, front and rear
- Doosan Connect Telematic system
- Work light kit (rear and front)
- Load weighing system

Cab & Interior

- Armrest at operator seat
- Headrest at operator seat
- Safety belt at operator and instructor seat
- Adjustable steering column
- All instrumentation in LCD display
- Cigarette lighter
- 12 V and USB charging point
- Retractable roller sunblind
- Tinted safety glass
- Sliding window (left & right side)
- Windshield wiper and washer
- Side mirrors
- Protection for rear window
- Emergency steering, ground-driven
- Radio/MP3 and Bluetooth
- Cab tilting system
- Emergency shutdown switch
- Anti-slip steps & platform
- Cool box compartment
- Storage room
- Electronic climate control
- High-comfort seat (vertical and longitudinal suspension)
- Heated operator seat

OPTIONAL EQUIPMENT

BODY

- Tailgate
- Body lining (400 HB)
- Side extension (200mm/250mm)
- Body heating kit

Safety

- Seat belt green warning light
- Blue or orange flashing reverse light
- White noise alarm
- Air inlet Pre-Cleaner
- Protection for rear lights
- Wheel block

Other

- Webasto heating system (heat up the cooling system)
- Fire extinguisher
- First aid kit
- Beacon
- Light bar
- Speed limitation
- Work light kit (rear and front) LED
- Tool kit
- Warning triangle
- Fast fill
- Tire pressure monitoring system (may not be available with all tires)
- Electrical diesel refueling pump
- Electrical adjustable heated mirror
- Electrical engine heater (230V)

Tires options

- Quarry
- Earthmoving
- Flotation tires

Some of these options may be standard in some markets. Some of these options may not be available for certain markets. Please check with your local DOOSAN dealer for more information about availability or to adapt your machine to your application needs.



Tail gate



LED lights

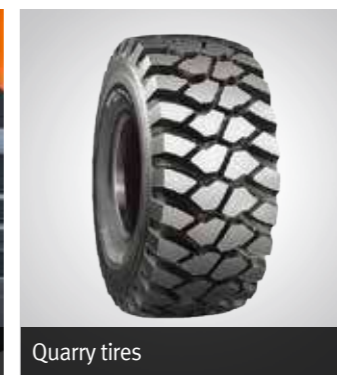

Quarry tires

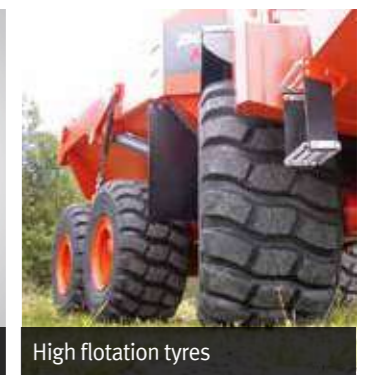

High flotation tyres

Doosan is

Since 1896, Doosan, the oldest company in Korea, has evolved with its people. The company grew up rapidly for last 10 years with reputation. For human-oriented vision, Doosan has been building constructions, energy, machines, infra structures globally. As a global leader of infra structure, Doosan continues its vision to make human-oriented future.

First in Korea, Doosan self-developed excavators in 1985 and continued building versatile construction machines including excavators, wheel loaders, articulated dump trucks to execute its human-oriented philosophy. Doosan became a global leader of heavy construction machine industry by achieving global sales line, producing line, and distribution line. Along with large production bases in Korea, China, USA, Czech, Doosan has 1400 dealer networks and Doosan is providing reliable products and trusted solutions for your stable business at no risk.



DIPBE-02-2008

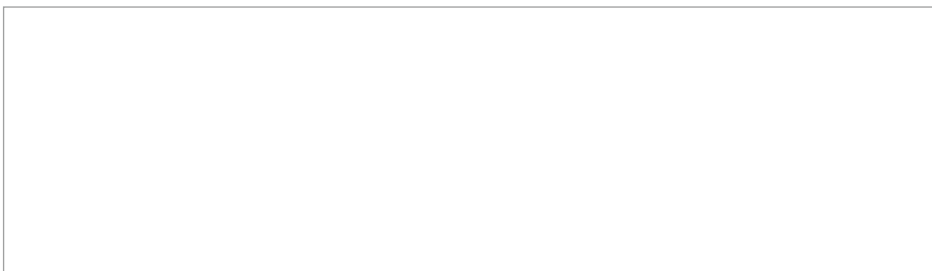

Doosan Infracore Co., Ltd.
489 (Hwasu-dong), Injung-ro, Dong-Gu,
Incheon, Korea (22502)
<https://global.doosanequipment.com>

Copyright 2020. Doosan Infracore. All rights reserved.